

Section A	56
Section B	44
Your score out of 100%	
Parent's signature	

Name : _____ Index No.: _____ Class: P6_____

20 AUG 2020

SCIENCE

Duration: 1 h 45 min

SECTION A (28 x 2 marks)

For each question from 1 to 28, four options are given. One of them is the correct answer. Make your choice (1, 2, 3 or 4). Shade the correct oval (1, 2, 3 or 4) on the Optical Answer Sheet (OAS) provided.

1 Study the animals in groups A and B below.

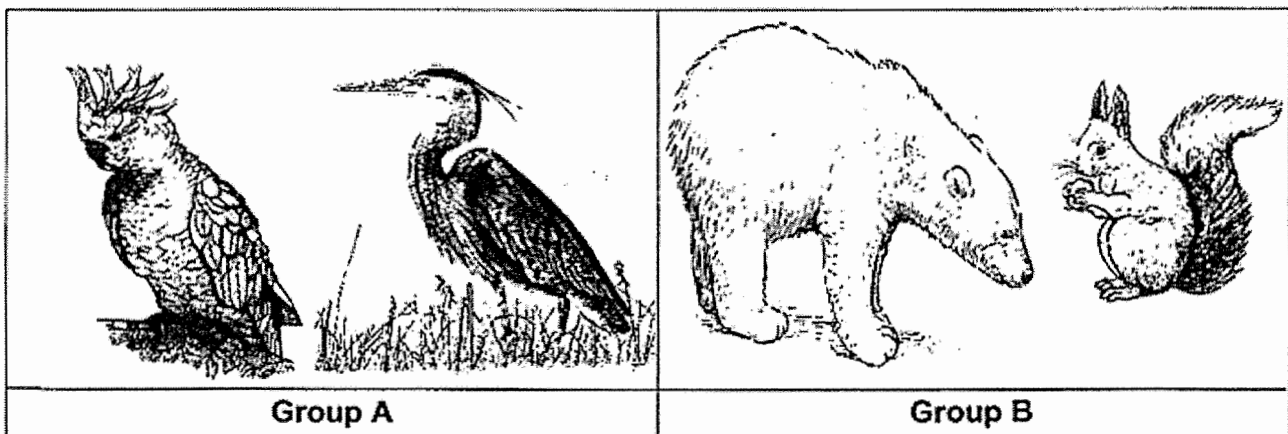

Which of the following is correct? A tick (✓) shows the presence of the characteristic(s) of the animals.

	Group	Has body covering of feathers	Has body covering of fur	Has wings
(1)	A		✓	✓
(2)	A	✓		✓
(3)	B		✓	✓
(4)	B	✓		

2 Which of the following statements about fungi are true?

- A Yeast is a type of fungi.
- B Fungi reproduce by spores.
- C Fungi are not made of cells.
- D Fungi do not have chloroplasts.

- (1) A and B only
- (2) C and D only
- (3) A, B and D only
- (4) B, C and D only

3 Observations made on animals P and Q are recorded in the table below.

Characteristic \ Animal	Has 3-staged life cycle	Lay eggs on land	Young resembles adult
P	√	√	√
Q	√		

Which of the following represents animals P and Q correctly?

	Animal P	Animal Q
(1)	butterfly	mosquito
(2)	butterfly	frog
(3)	cockroach	frog
(4)	cockroach	mosquito

4 Bethany investigated the conditions needed for the germination of green beans.

She prepared three set-ups, A, B and C, each containing same amount of cotton wool and the same number of green beans as shown below.

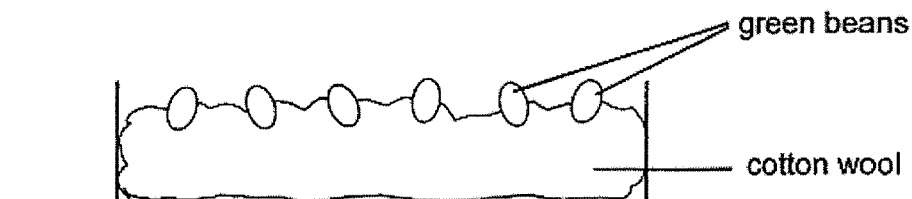

The table below shows the conditions each set-up was exposed to.

Set up	Conditions		
	Cotton wool	Temperature (°C)	Presence of light
A	damp	30	yes
B	dry	30	yes
C	damp	0	no

Bethany recorded the observations on the green beans after five days.

Which of the following observations correctly matches the reason?

	Observation	Reason
(1)	Green beans in set-up A germinated.	Air, water and light ^{warmth} needed for germination were present.
(2)	Green beans in set-up A germinated.	Air, water and warmth needed for germination were present.
(3)	Green beans in set-up B did not germinate.	No light was present.
(4)	Green beans in set-up C did not germinate.	No warmth and light were present .

5 The diagrams below show the reproductive systems of a plant and human.

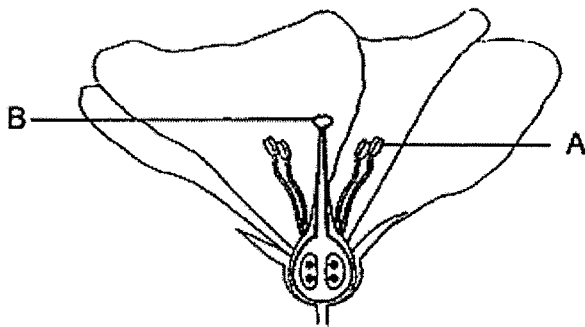

Plant reproductive system

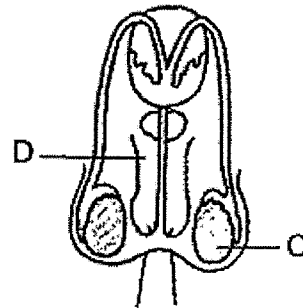

Human reproductive system

Which of the following represent the parts involved in producing the male reproductive cells?

- (1) A and C
- (2) A and D
- (3) B and C
- (4) B and D

6 The diagram below shows how a fruit is developed from a flower.



Which of the following correctly identifies processes X and Y?

	Process X	Process Y
(1)	seed dispersal	fertilisation
(2)	fertilisation	seed dispersal
(3)	fertilization	pollination
(4)	pollination	fertilisation

7 The diagrams below show two flowers, G and H, from the same type of plant.

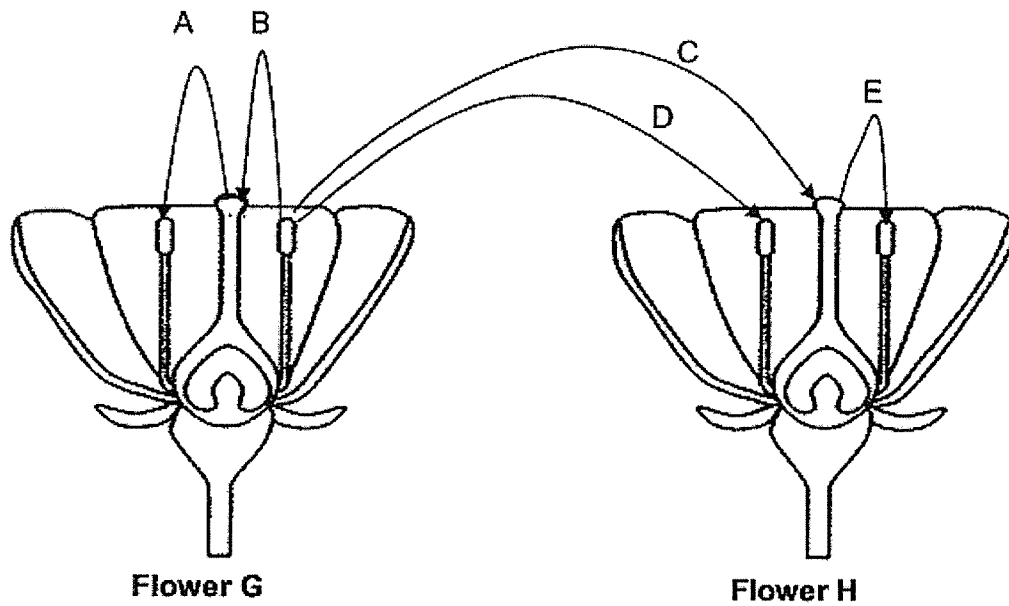

Which is / are the arrow(s) that represent(s) the process pollination?

- (1) C only
- (2) D only
- (3) B and C only
- (4) A and E only

8 Sarah wanted to find out if overcrowding affects plant growth. The table below shows four different set-ups, P, Q, R and S, each containing the same amount of soil. She watered each set-up with the same amount of water daily.

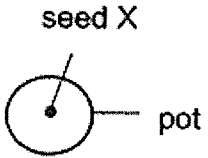
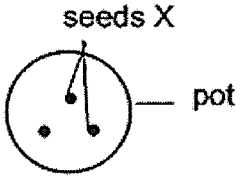
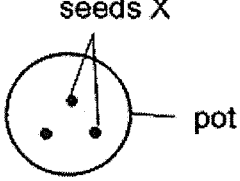
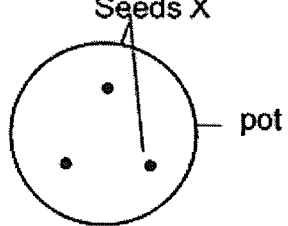
Set-ups	Conditions		
	Size of pot and number of seeds	Location	Temperature (°C)
P		classroom	25
Q		garden	35
R		garden	25
S		garden	35

Which set-ups, P, Q, R and S, should Sarah use to ensure a fair test?

- (1) P and R only
- (2) P and S only
- (3) Q and S only
- (4) Q and R only

- 9 The chart below shows the amount of food digested in various parts of the human digestive system six hours after a meal.

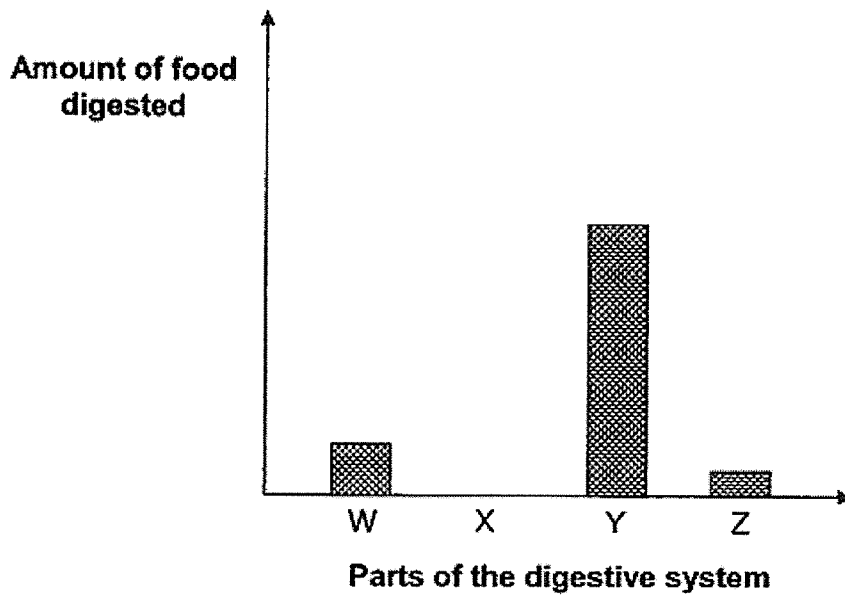

Based on the graph above, which one of the following best represents W, X, Y and Z respectively?

	W	X	Y	Z
(1)	stomach	large intestine	small intestine	mouth
(2)	stomach	mouth	small intestine	large intestine
(3)	mouth	small intestine	large intestine	stomach
(4)	small intestine	large intestine	mouth	stomach

- 10 Norris prepared set-ups A, B and C using the same type of plant. She removed some roots from the plants in set-ups B and C and removed some leaves from the plant in set-up C as shown in the diagrams below. She observed the volume of water left in each set-up over a period of one week.

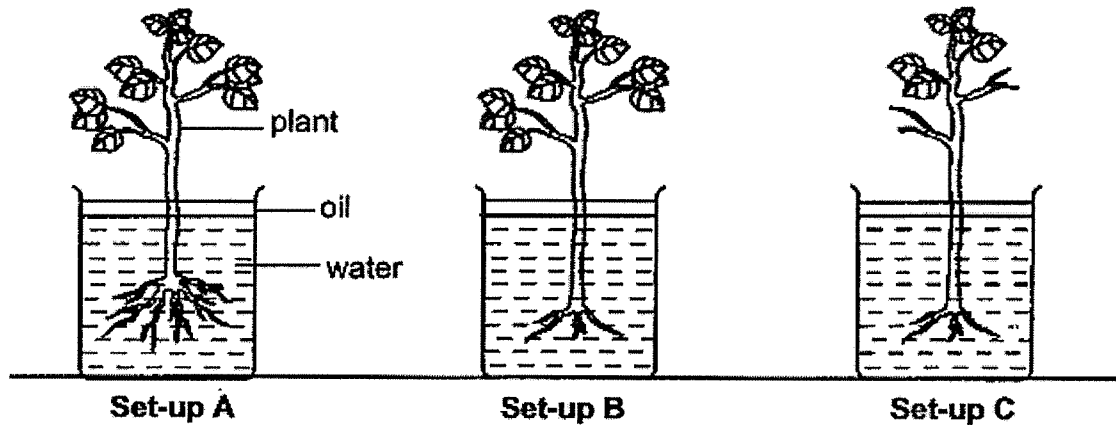

Which of the following graphs best represents the results obtained for the three set-ups, A, B and C?

(1)

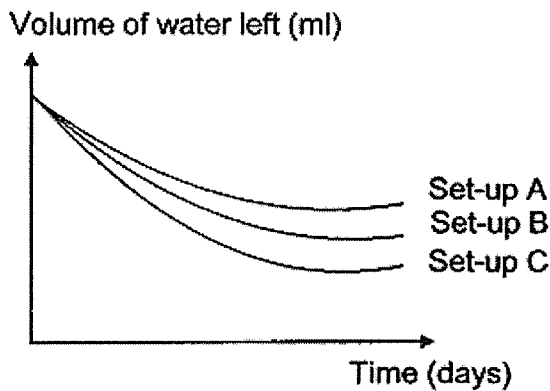

(2)

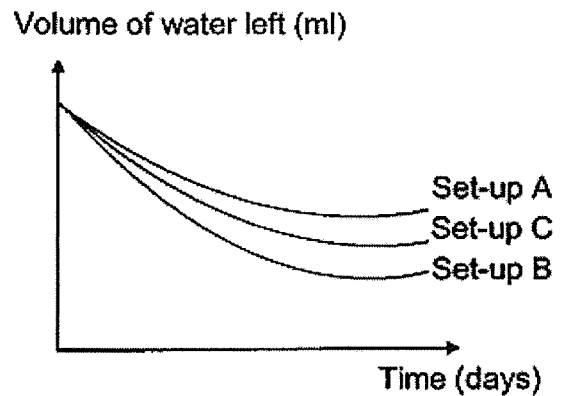

(3)

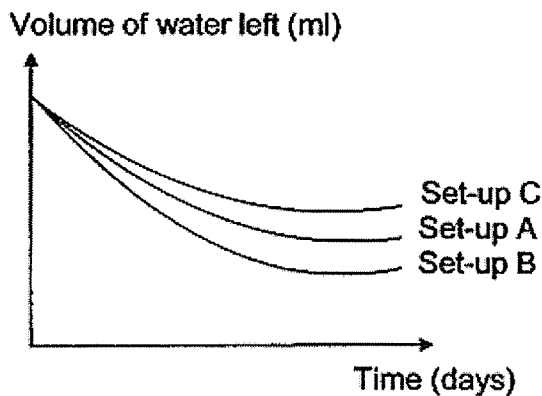

(4)

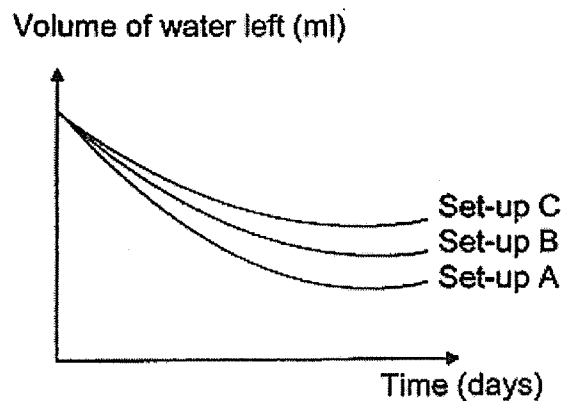

11 Which one of the following parts is found in a root cell but not in a cheek cell?

- (1) cell wall
- (2) cytoplasm
- (3) chloroplast
- (4) cell membrane

12 Denise prepared set-ups A, B, C and D as shown below.

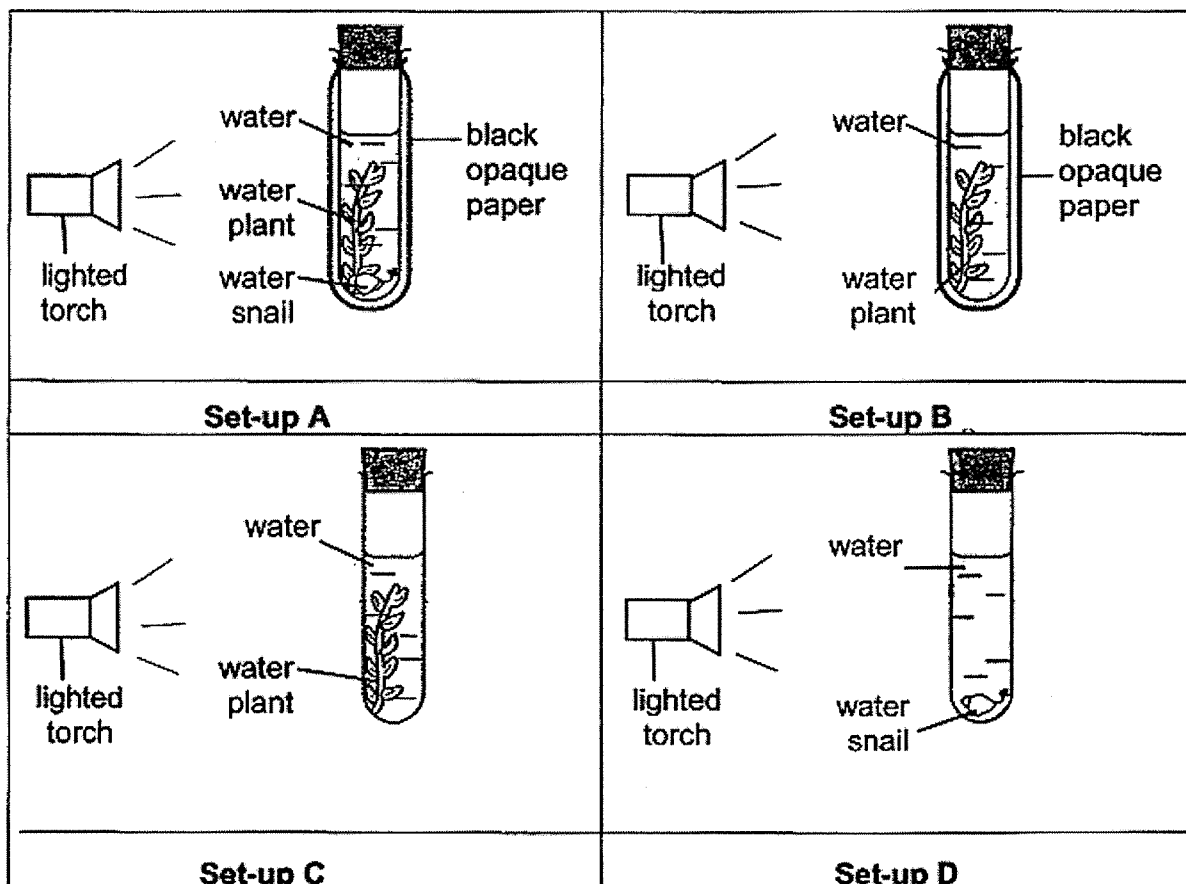

She measured the concentration of carbon dioxide in the water in each test-tube before the experiment and two hours later.

In which test-tube would there be a decrease in the concentration of carbon dioxide after two hours?

- (1) Set-up A
- (2) Set-up B
- (3) Set-up C
- (4) Set-up D

13 Gabi wanted to construct a flying model as shown in the diagram below.

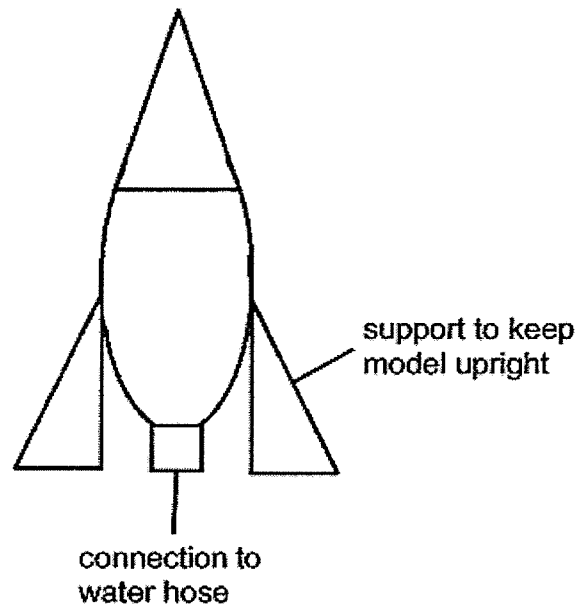

She wanted to conduct a test launch where the flying model would fly to a height of one metre when filled with water and that it would not be damaged when it landed on the ground.

Which of the following properties must she consider while selecting the materials to build her flying model?

- (1) Strength and waterproof.
- (2) Strength and conductor of heat.
- (3) Conductor of heat and flexibility.
- (4) Conductor of electricity and waterproof.

- 14 A sealed container holds 700 cm^3 of oil and 300 cm^3 of air as shown below. Another 200 cm^3 of oil is removed and 100 cm^3 of air is added to the container through the pump.

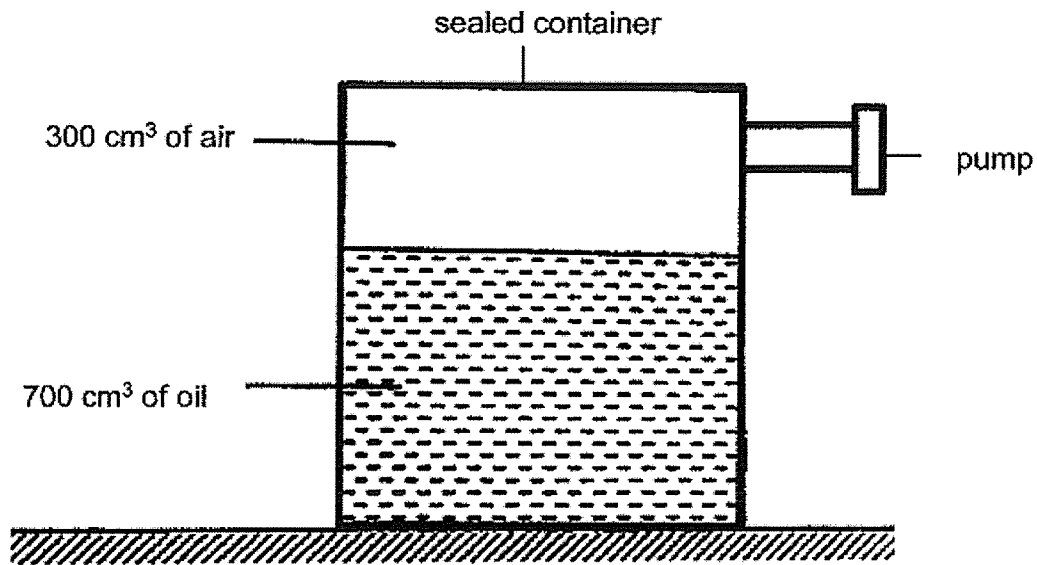

What is the final volume of air in the container?

- (1) 300 cm^3
- (2) 400 cm^3
- (3) 500 cm^3
- (4) 600 cm^3

- 15 Tim had a bag of identical marbles. He wanted to find the volume of each marble. He filled a measuring cylinder with water as shown in diagram below.

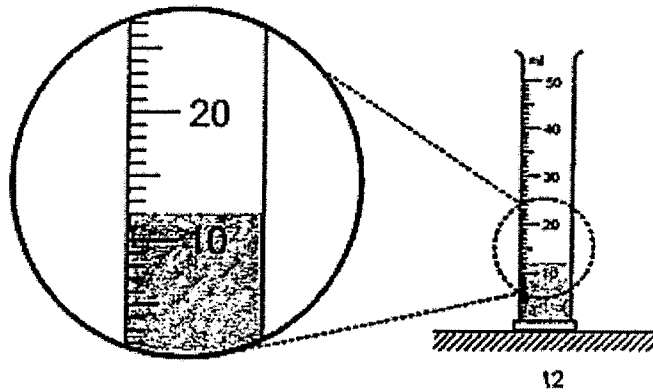

Tim then put ten marbles in the measuring cylinder of water. His result is shown below

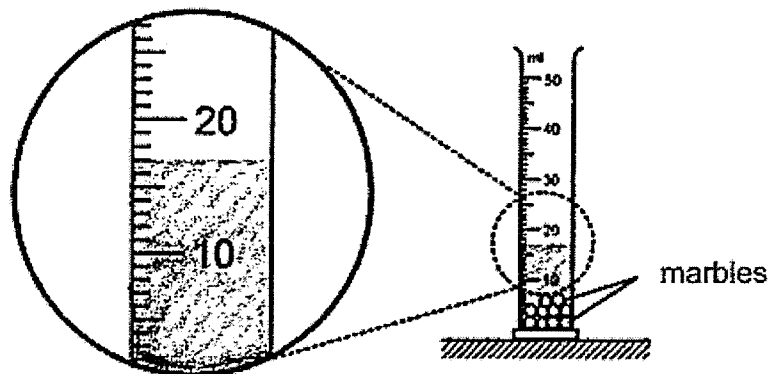

Based on Tim's experiment, which of the following is correct?

- A Marbles occupy space.
- B Water has no definite volume.
- C The volume of each marble is 5 cm^3 .

- (1) A only
- (2) B only
- (3) A and C only
- (4) A, B and C

- 16 The table below shows the freezing point and boiling point of three substances, X, Y and Z.

Substance	Freezing point (°C)	Boiling point (°C)
X	6	80
Y	17	118
Z	43	181

Which of the substances, X, Y or Z, is/are liquid(s) at 90°C?

- (1) X only
- (2) Y only
- (3) Y and Z only
- (4) X and Z only

- 17 Dora wanted to investigate the electrical conductivity of rods A, B, C and D. She constructed the circuit as shown below.

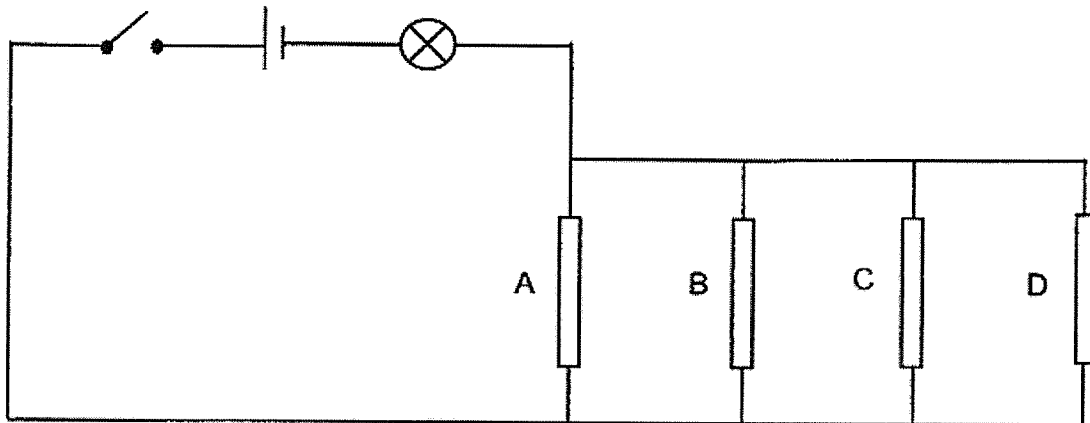

She recorded her observation below when she removed certain rods and closed the switch.

Rod(s) removed from the circuit	Bulb lighted up
D	yes
B and C	yes
B, C and D	no
A, B, D	no

Based on her observation, which of the following conclusions about the rods A, B, C and D is correct?

	Electrical conductor(s)	Electrical insulator(s)
(1)	A, C	B, D
(2)	B, C, D	A
(3)	A	B, C, D
(4)	B, D	A, C

- 18 The circuit below consists of identical bulbs, B1, B2, B3 and B4, all lit up.

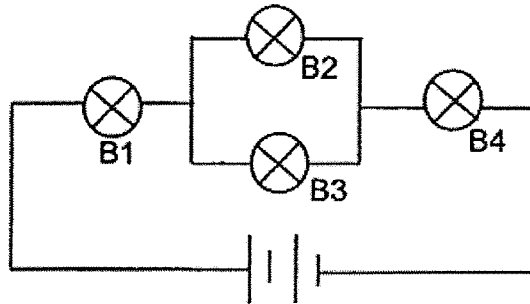

Which of the following is likely to be observed when only one of the bulbs in the above circuit is fused at one time?

	Bulb that was fused	Smallest number of bulbs remaining lit	Largest number of bulbs remaining lit
(1)	B1 or B4	0	3
(2)	B1 or B3	1	2
(3)	B2 or B3	2	3
(4)	B2 or B4	0	3

19. A steel bar XY was magnetised using the "stroke" method as shown in Diagram 1 below. Diagram 2 shows the magnetic poles of XY after it was magnetised.

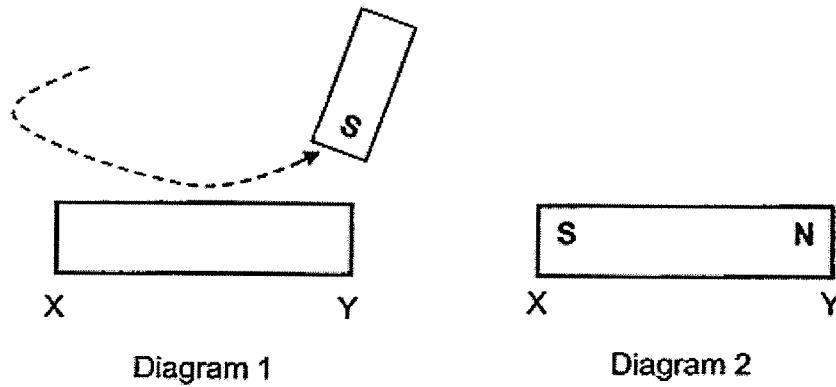

Another steel bar below was magnetised using two magnets as shown in Diagram 3.

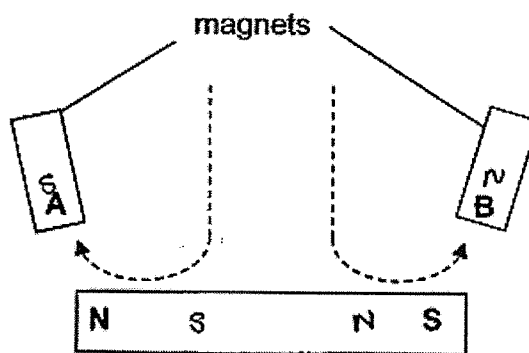
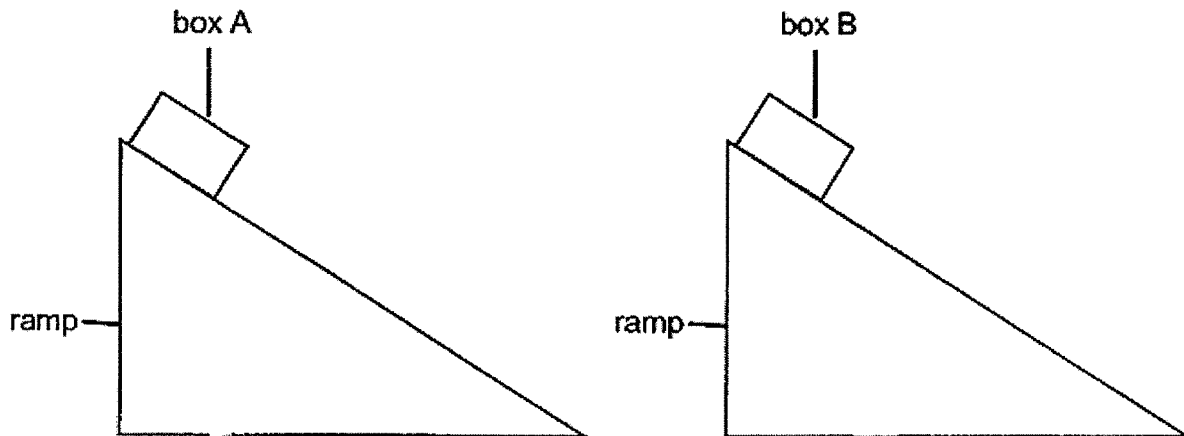

Diagram 3

Identify the poles at A and B used to magnetise the steel bar respectively.

	Poles at A	Poles at B
(1)	N	S
(2)	S	N
(3)	N	N
(4)	S	S

20. Ali, Beth, Cailling, and Devi prepared the following set-ups using identical boxes A and B as shown below.



The boxes were placed at the same starting point on the ramps. They observed that box B would slide down the ramp but box A remained stationary.

The pupils made the following statements:

Ali	The gravitational force acting on both boxes was the same.
Beth	The gravitational force acting on box B was more than that of box A.
Cailling	The surface of the ramp where box A was placed on was smoother.
Devi	The frictional force between box B and the surface of the ramp was less than that of box A and the surface of the ramp.

Which of the pupils made the correct statements?

- (1) Ali and Cailling
(2) Ali and Devi
(3) Beth and Cailling
(4) Beth and Devi

21 Which of the following arrows shows the direction of frictional force acting on a ladder which is leaning against the wall?

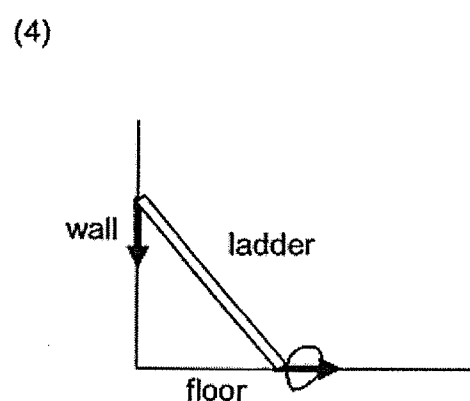
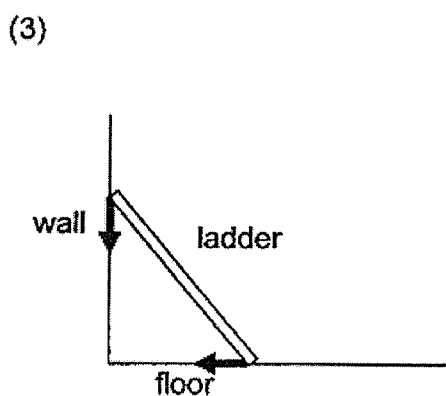
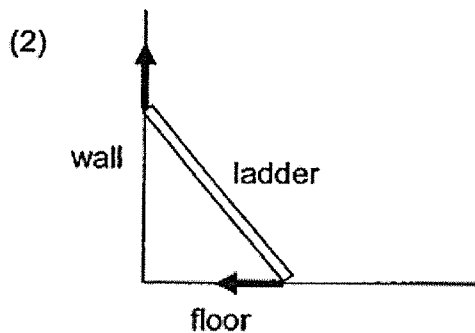
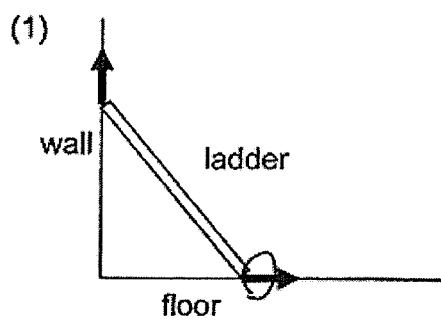

- 22 Stella carried out an experiment to find out which rubber ball, P, Q or R, travelled the furthest distance when it was rolled down the same ramp as shown below. The rubber balls were identical in size but of different masses.

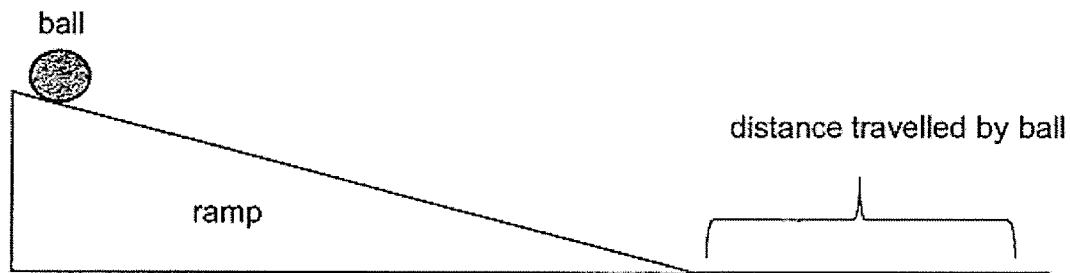

For each ball, she repeated the experiment three times. She recorded the distance travelled by each ball in the table below. However, she did not carry out a fair test when conducting the experiment with ball R.

Distance travelled by balls (cm)				
	1 st try	2 nd try	3 rd try	Average
P	141	143	146	143.3
Q	183	184	180	182.3
R	90	125	680	142.5

Based on the results of the above experiment, which of the following statements is/are most likely to be true?

- A The amount of gravitational force acting on ball Q was the least.
 - B The way she released ball R was not the same for all the three tries.
 - C Ball R was released at different positions on the ramp at each repeated experiment.
- (1) A only
(2) B only
(3) B and C only
(4) A, B and C

23. A light sensor is used to count the number of wooden blocks on a moving belt in a factory as shown in the set-up below.

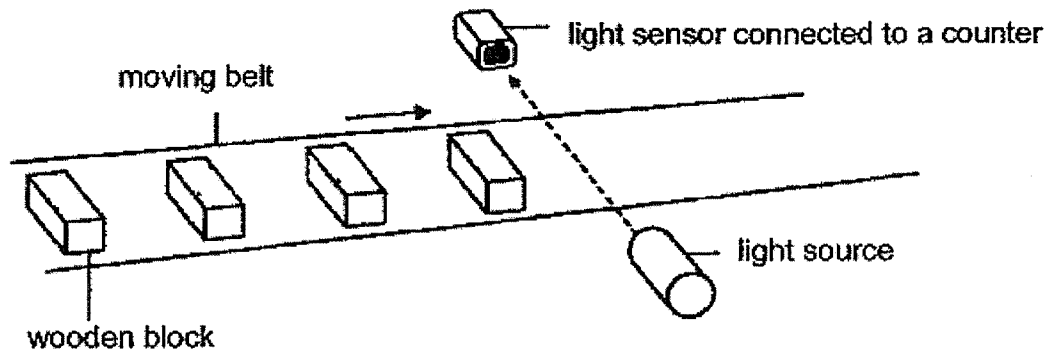

The belt moves at a constant speed. The workers plotted the results in the graph shown below.

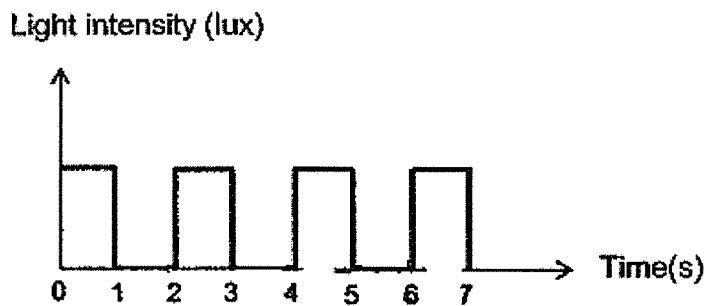

Based on the graph above, how many wooden blocks were counted in five seconds?

- (1) 2
- (2) 3
- (3) 4
- (4) 5

- 24 The diagram below shows a lamp post. The distance from A to B is identical to the distance from B to C. David walked under the lighted lamp post from B to C, then C to A passing B again. He increased his speed while walking from B to A.

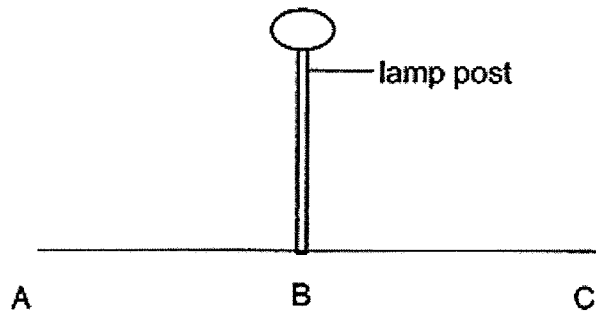

Which one of the diagrams below shows the changes in the length of the boy's shadow over the period of time?

(1) Length of shadow (cm)

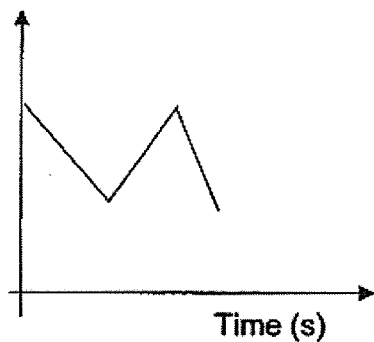

(2) Length of shadow (cm)

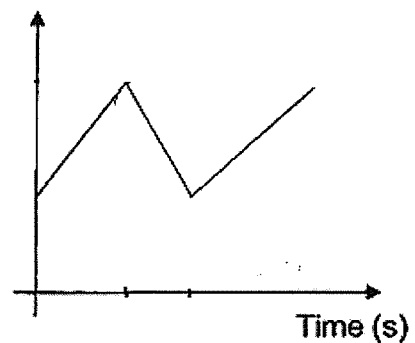

(3) Length of shadow (cm)

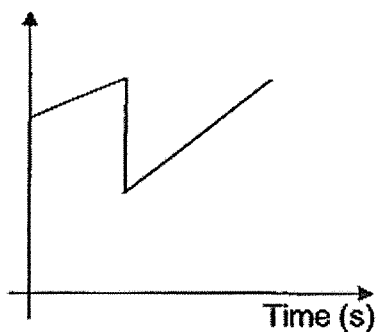

(4) Length of shadow (cm)

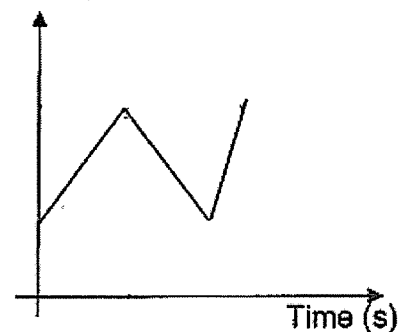

25 Emma carried out an experiment with the two set-ups X and Y as shown below. She used identical containers and burners for the two set-ups.

In set-up X, she placed a blob of wax on a surface which was placed 5cm above the base of the container.

In set-up Y, she placed the same amount of wax on an identical surface. The surface was raised 15 cm above the base of the container as shown below.

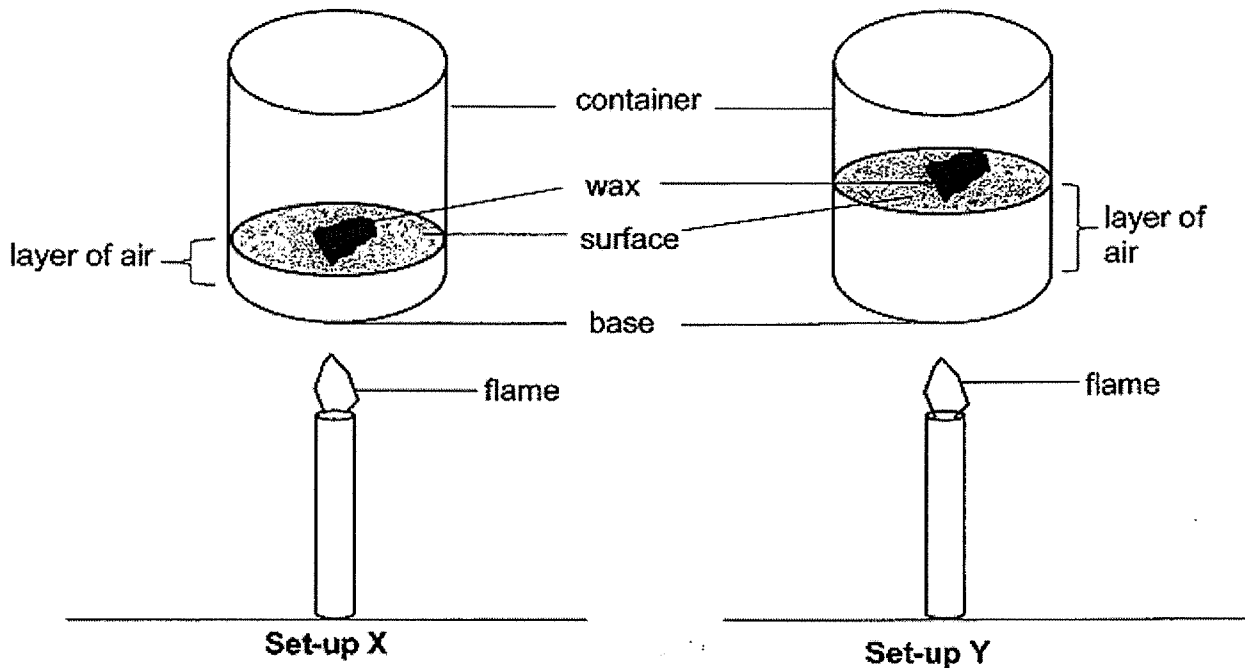

She recorded her observation in the table below.

Layer of air between wax and base of container (cm)	Time taken for wax to melt (s)
5	20
15	85

Continue on next page

Continued from previous page

Based on the results of the experiment, Emma attempted to prepare fried ice cream. It is a dessert where coated ice cream is quickly deep fried to create a golden and crispy shell around the still cold ice cream.

She prepared the flour dough using a mixture of water, baking soda and flour. She coated the identical ice creams with different amounts of flour dough as shown below.

Then they were deep fried using the same amount of heat for ten seconds until golden brown.

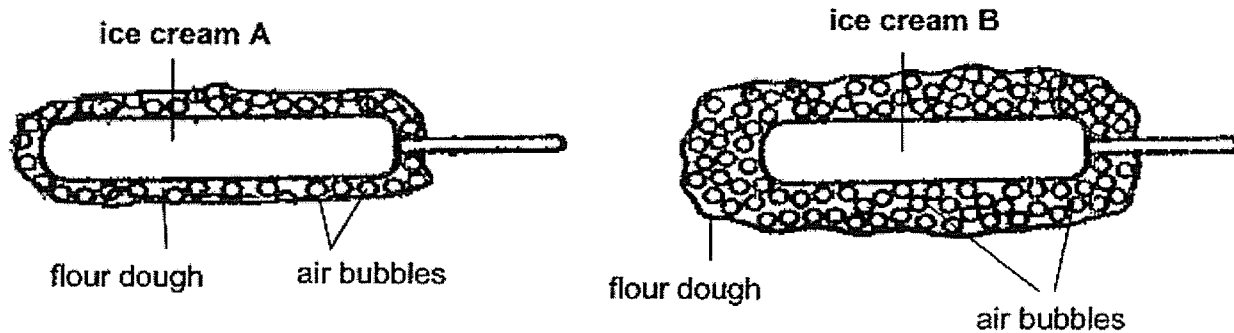

Emma observed that one of the ice creams melted after ten seconds. Which one of the following is correct?

	Ice cream that melted	Reason
(1)	A	The flour dough is a good conductor of heat.
(2)	A	There was less air in the dough. Thus, the ice cream gained heat faster.
(3)	B	The air in the air bubbles is a poor conductor of heat.
(4)	B	The flour dough has more air bubbles round the ice cream.

- 26 Alison prepared the set-up shown below using the same amount of wax to hold the identical thumbtacks on the materials A and B respectively. The materials are of identical length. The thumbtacks were placed at equal distance away from the heat source. Alison observed the thumbtack on material B drop off first.

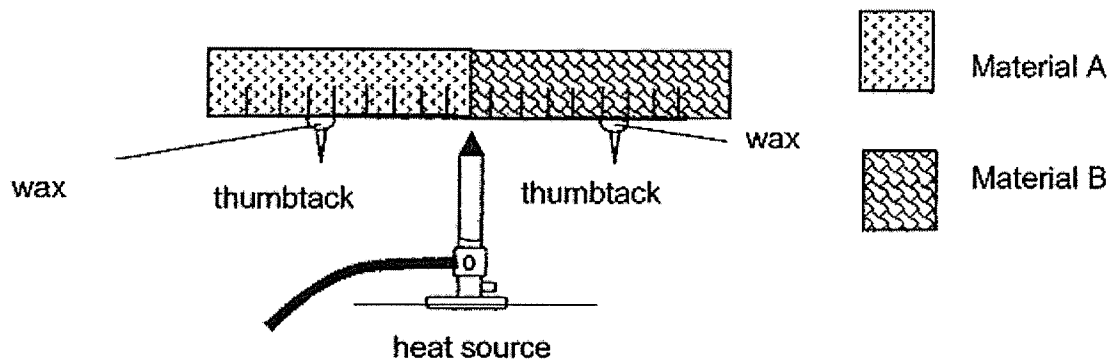

Next, she wrapped a piece of paper round materials A and B as shown below and put over a heat source. She observed the piece of paper after three minutes.

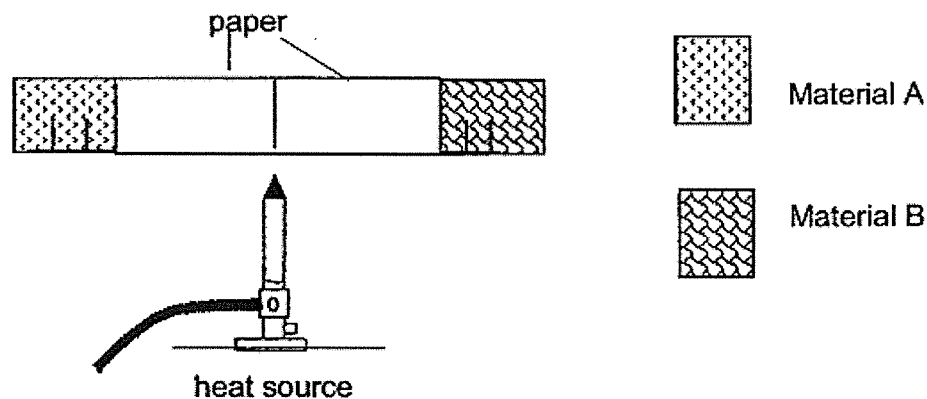

Which of the following provides the correct observation and explanation?

	Observation	Explanation
(1)	The paper on material A would burn.	Material A conducted heat to the paper more quickly.
(2)	The paper on material A would burn	Material A conducted heat away from the paper more slowly.
(3)	The paper on material B would burn	Material B conducted heat to the paper more quickly.
(4)	The paper on material B would burn	Material B conducted heat away from the paper more slowly.

27 Linda designed a model as shown below.

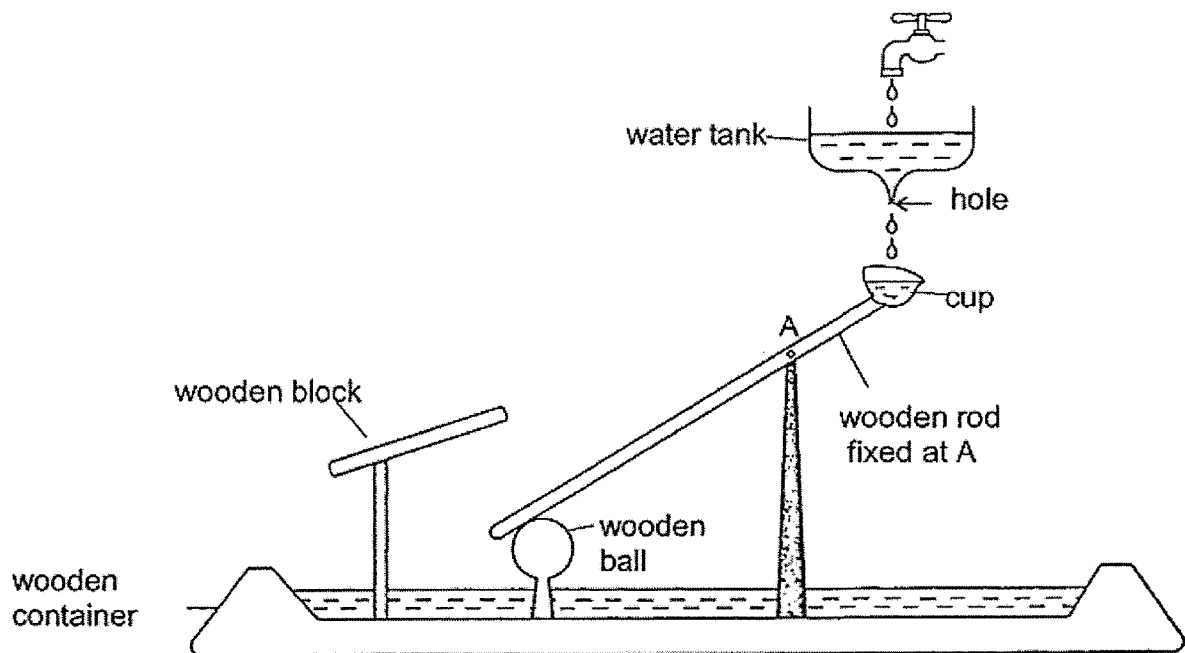

The cup is fixed onto a wooden rod which can move at pivot A. Water from a tank is dripped into the cup. When the cup is filled up with water, it moved down, causing the other end of the rod to hit against the wooden block.

Which of the following should Linda change to enable her model to produce a louder sound?

- A increase the size of the hole
- B increase the size of the wooden ball
- C change the wooden ball to a metal ball
- D increase the height of the tank above the wooden container

- (1) A only
- (2) C and D only
- (3) A and D only
- (4) A, B and C only

- 28 Trina conducted an experiment using springs X and Y. She hung different numbers of weights one at a time and recorded the length of the springs. Her results were shown in the graph below.

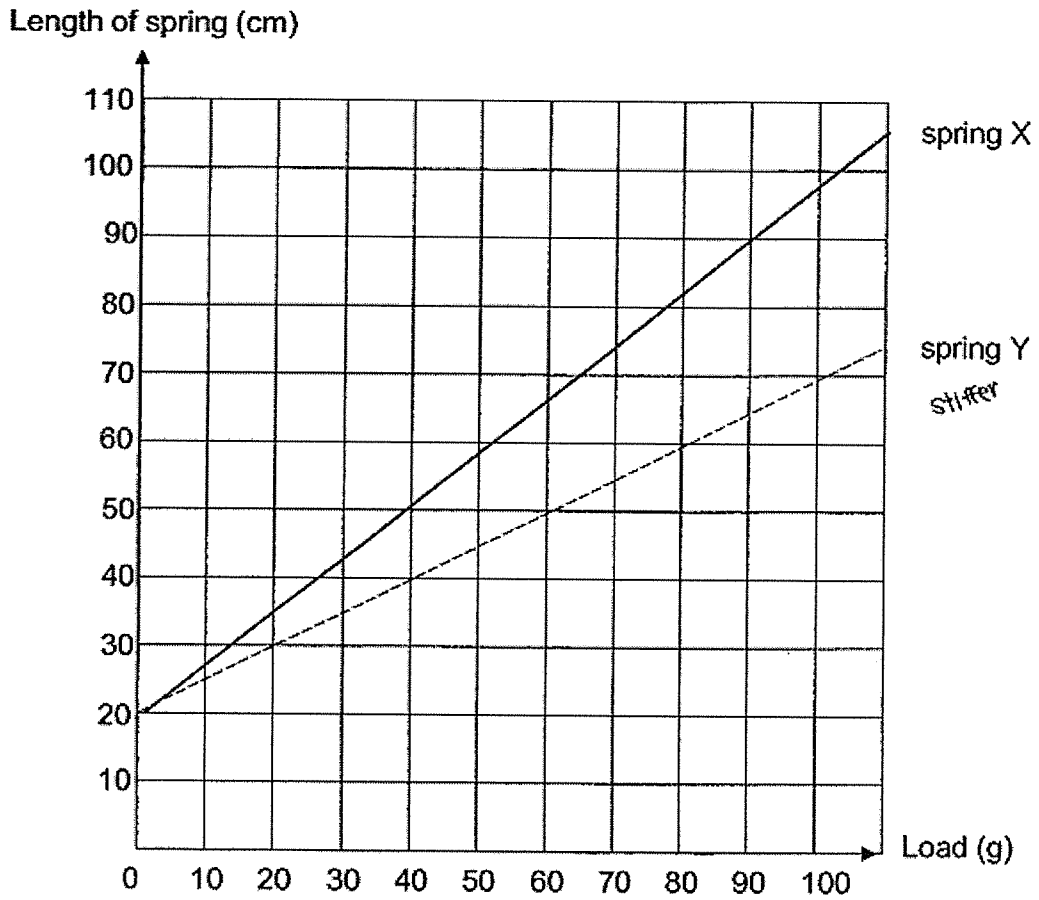

Continue on next page

Continued from previous page

The two springs, X and Y, were used to make the two dish racks, which hold identical number of plates as shown below.

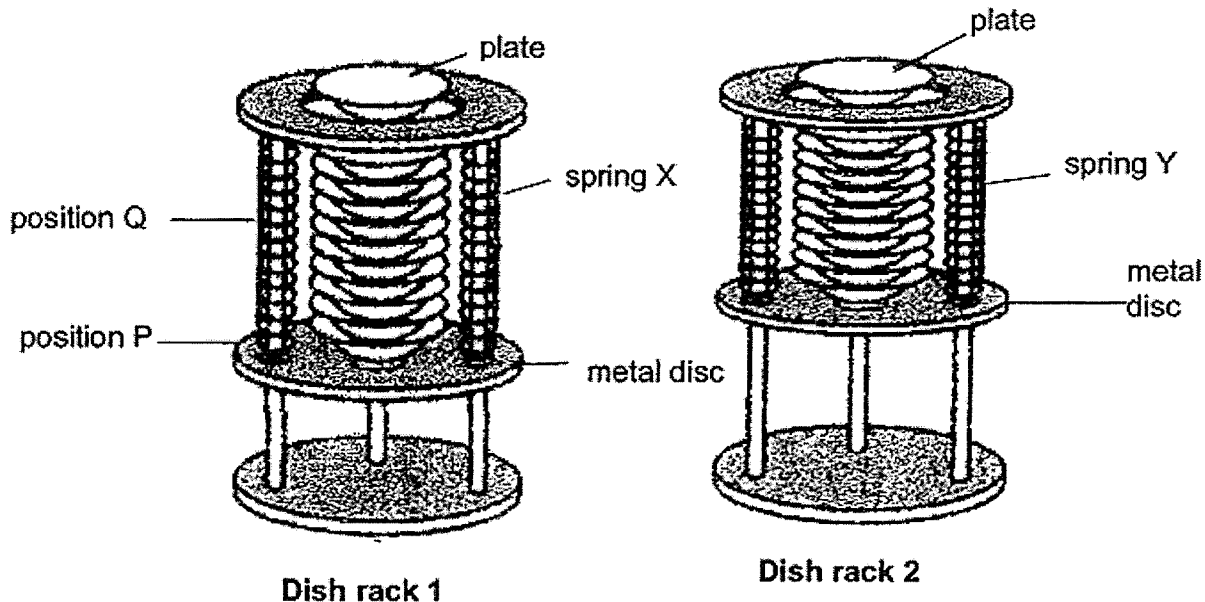

When Trina removed three plates from the top of dish rack 1, the metal disc moved up from P to Q. She also removed three plates from dish rack 2.

Based on the graph and the information provided, which of the following statement(s) is / are true when three plates were removed from the two dish racks?

- ? A The metal discs on both racks have gravitational potential energy and elastic potential energy.
- B The metal disc on dish rack 1 will have less gravitational potential energy than the metal disc in dish rack 2.
- C The metal discs for both racks moved up because the stretched springs exerted a pulling force on the metal discs.
- D The metal disc moved up as the weight of the plates is greater than the elastic spring force acting on the metal discs.

- (1) A and B only.
(2) A and C only
(3) B and C only
(4) B and D only

Name: _____ Index No: _____ Class: P6

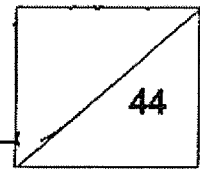

SECTION B (44 marks)

For questions 29 to 41, write your answers clearly in the spaces provided.

The number of marks is shown in brackets [] at the end of each question or part question.

29 Study the chart below.

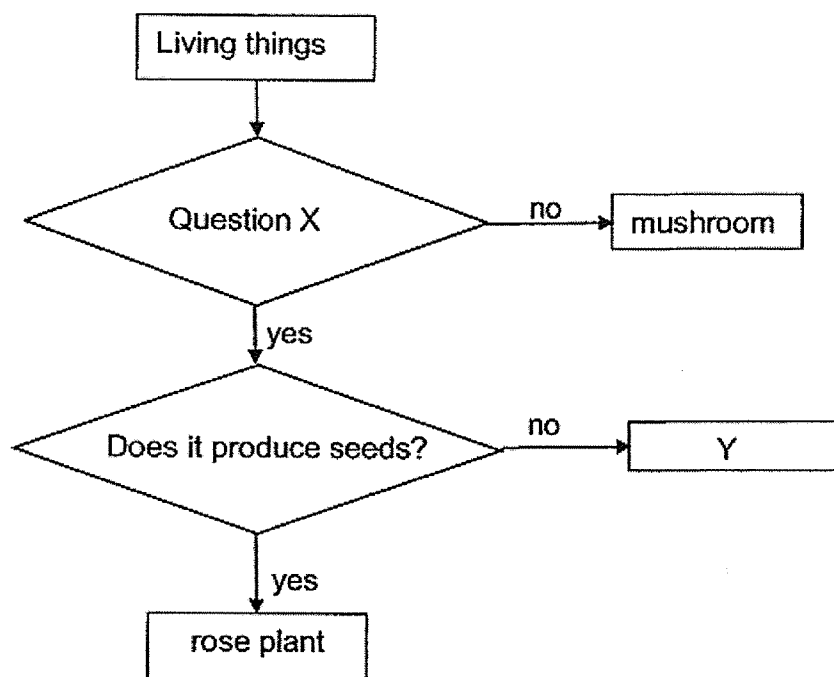

(a) Based on the chart above, fill in blanks with the correct answers. [1]

Question X: _____

Y: _____

(b) How does organism Y reproduce? [1]

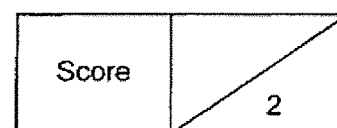

- 30 The diagram shows the characteristics of three fruits, P, Q and R, found in a park. A tick (✓) shows the presence of the characteristic of the fruits.

Fruit	Characteristic of fruit		
	Edible juicy flesh	Wing-like structure	Pod-like structure
P	✓		
Q		✓	
R			✓

Study the chart below.

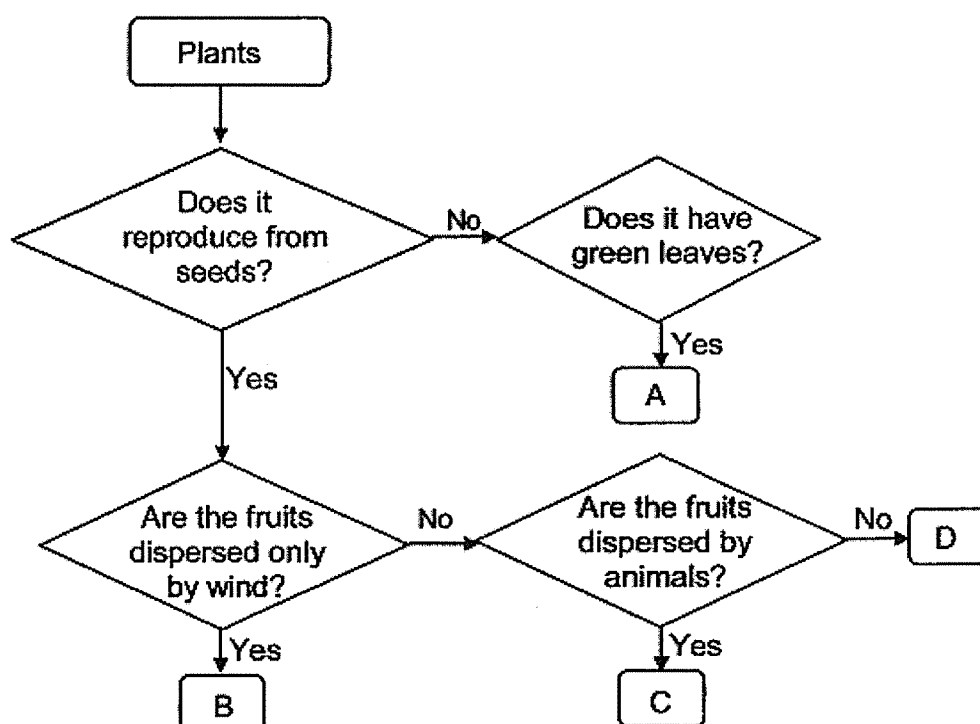

- (a) Based on the information from the chart above, state one similarity between Plant B and Plant D. [1]

Continue on the next page

Score	1
-------	---

Continued from previous page

(b) Based on the information from the table and the chart on the previous page, which plants, A, B, C and D, in the chart best represents plants that bear fruits P, Q and R? [1]

(i) P : Plant _____ (ii) Q : Plant _____ (iii) R : Plant _____

The number of young plants that bear fruits P and R were found at various distances from their parent plants as shown in the graph below.

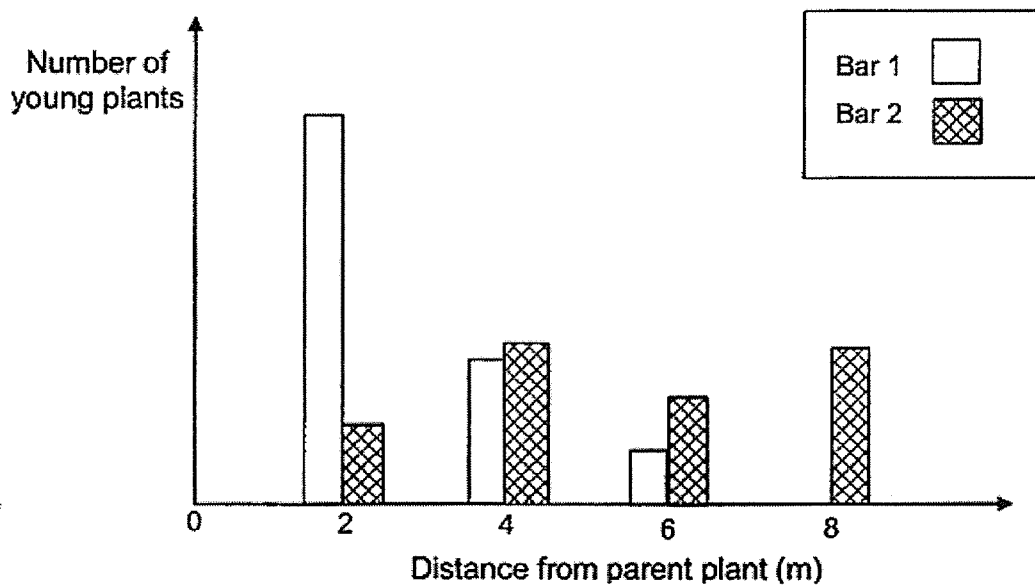

(c) Based on the information above, which bar, 1 or 2, represents the results recorded for plants of fruit P. Explain your answer. [2]

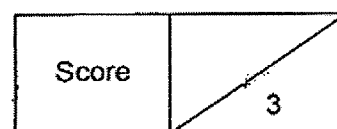

31 The diagram below shows a plant.

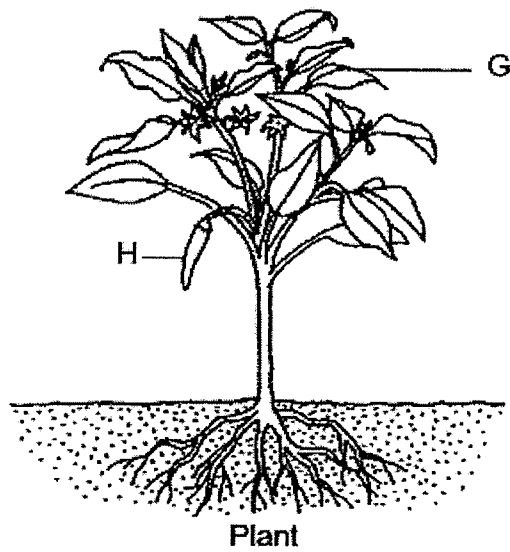

(a) State the main function of part G. [1]

(b) State the part of the flower that part H developed from. [1]

(c) Four parts of the plant are listed below. Draw arrows (→) in the diagram below to show how food is transported in the plant. [1]

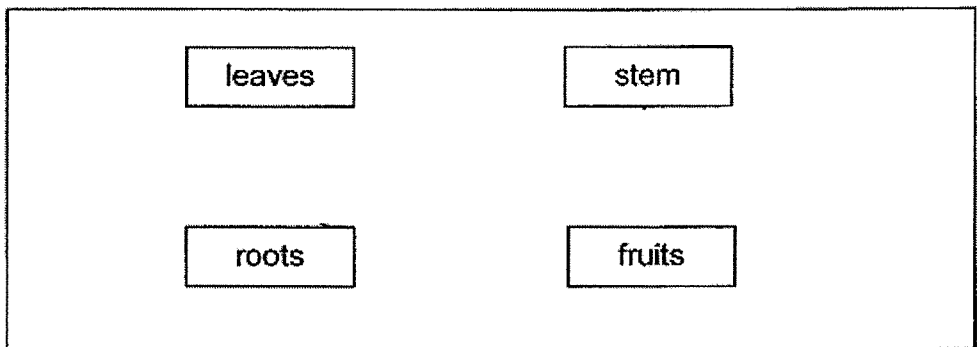

Score	3
-------	---

- 32 Ali wanted to find out how the distance between the lamp and the test-tube of an aquatic plant would affect the number of bubbles produced by the plant. He prepared two set-ups, A and B, as shown below.

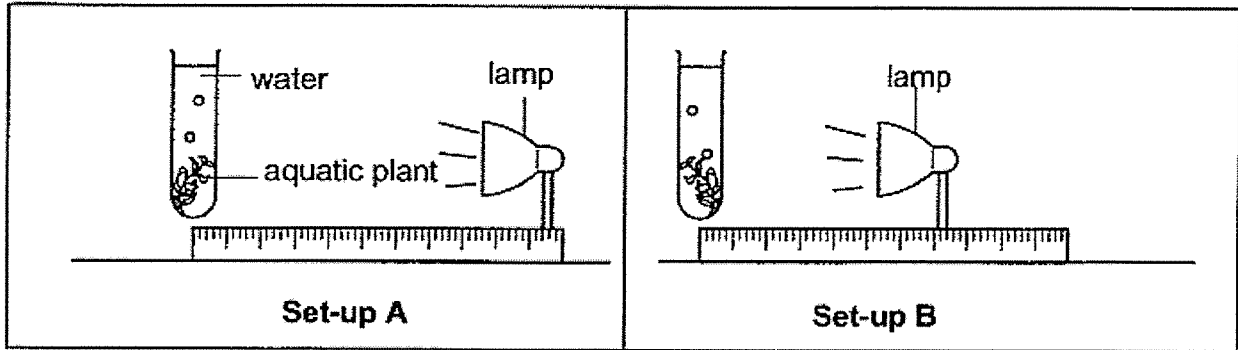

He counted the number of bubbles produced per minute for both set-ups. His results are as shown.

Set-up	Number of bubbles produced per minute
A	17
B	33

- (a) Based on Ali's results, explain how the distance between the lamp and the test-tube of the aquatic plant affect the rate of photosynthesis. [2]

- (b) State two variables that Ali has to keep constant when conducting this experiment. [1]

- (c) Ali recorded the initial mass of the aquatic plants before the experiment and the final mass of the aquatic plants in each set-up after three days. Both lamps were switched on continuously for three days. Which plant would have a greater increase in mass? Explain your answer. [2]

Score	5
-------	---

2020 P6 Science Prelim

- 33 Two identical cups, X and Y, were balanced on a rod. A burning candle was placed below cup X as shown below.

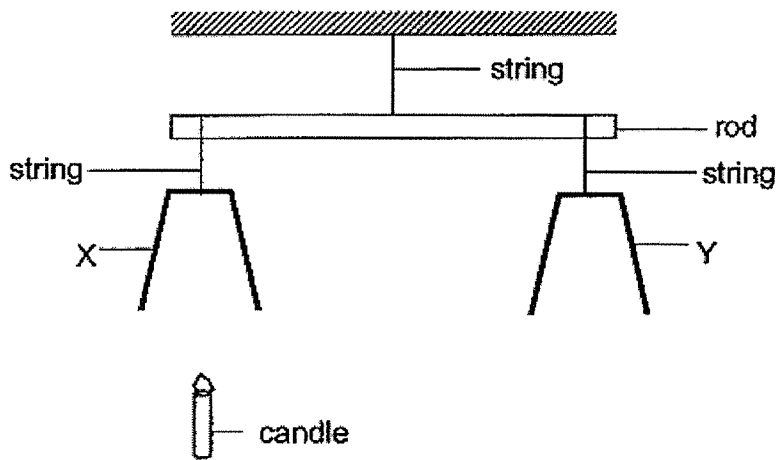

- (a) Would the rod tilt downwards towards X, remain balanced or tilt downwards toward Y? Explain your answer [2]

Changes were made to the set up by replacing cup Y with cup M, made of a different material.

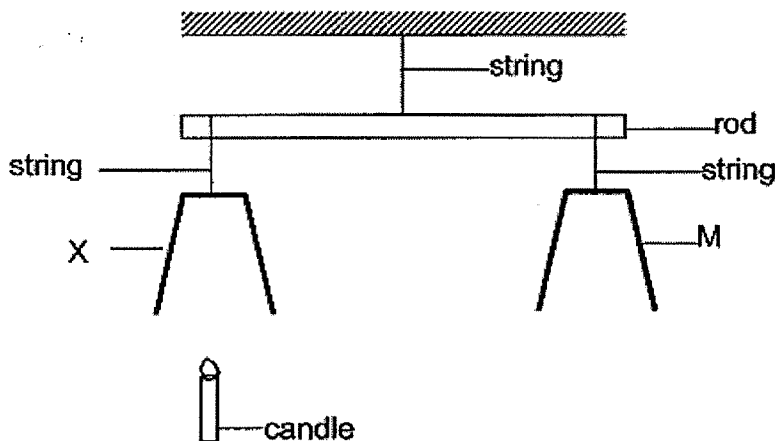

- (b) It was observed that the rod was balanced only when the candle was placed under cup X. Explain the observation. [2]

Score	4
-------	---

34 The diagram below shows the change of state of water.

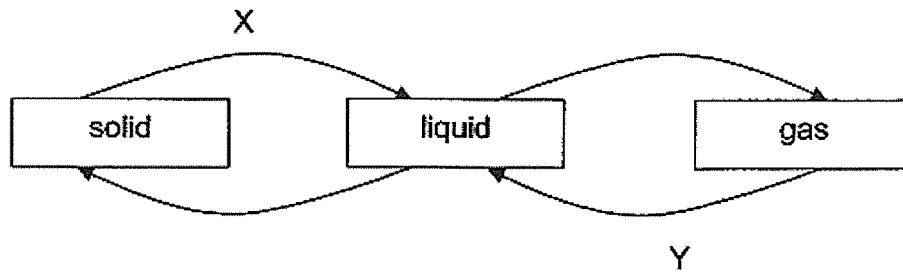

(a) Name the processes X and Y. [1]

Process X: _____

Process Y: _____

(b) Michelle bought some slices of hot crispy toasted bread for her grandfather and then walked home.

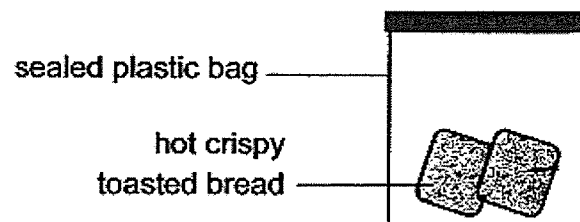

(i) When she reached home, she found that the slices of crispy toasted bread were damp. Explain her observation. [2]

(ii) Suggest what Michelle could have done to ensure the slices of toasted bread remained crispy by the time she reached home. [1]

Score	4
-------	---

- 35 Jason made a toy train and a steel tunnel. Both had a height of 10 cm. The aluminium strips were attached to the toy train. The diagram below shows his toy train set.

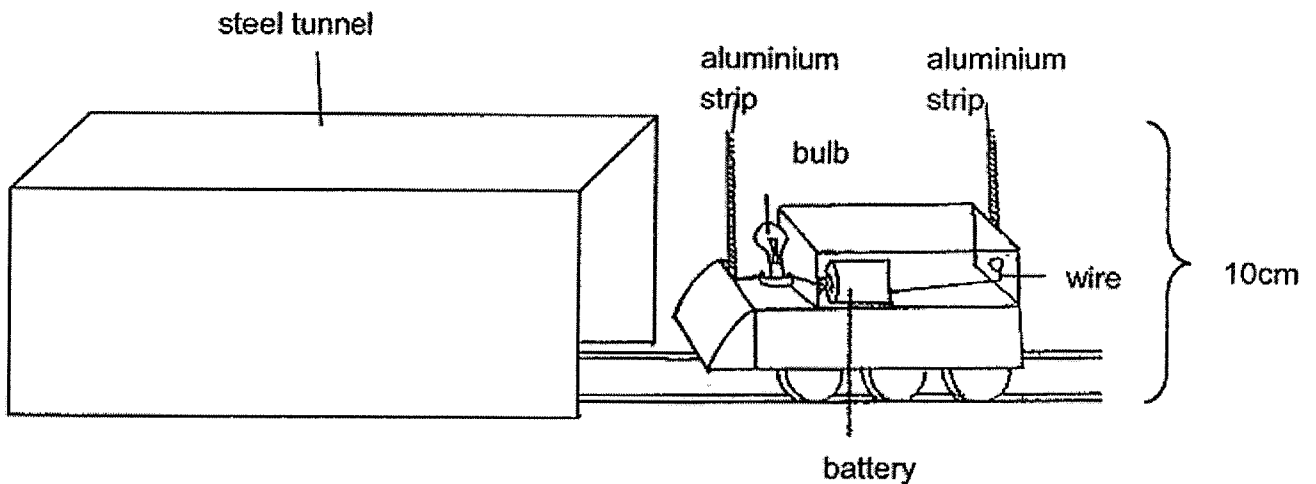

- (a) Jason observed that the light bulb on the toy train only lit up when the train was moving completely under the steel tunnel.

Explain why the bulb on the toy train only lit up when it was moving completely in the steel tunnel. [2]

Continue on next page

Score	2
-------	---

Continued from previous page

Jason replaced the steel tunnel with another tunnel that was made of plastic and steel as shown in the diagram below. The height of the new tunnel was also 10 cm.

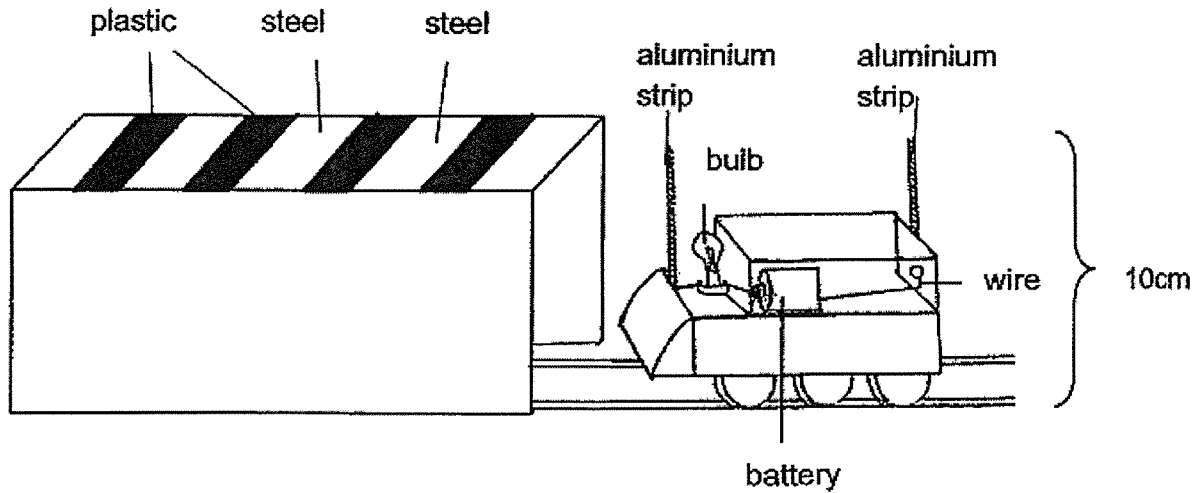

- (b) Describe what Jason would observe of the bulb while the same toy train was moving through the new tunnel shown above. [1]

Score	1
-------	---

36 The toy car below moves along the wooden plank.

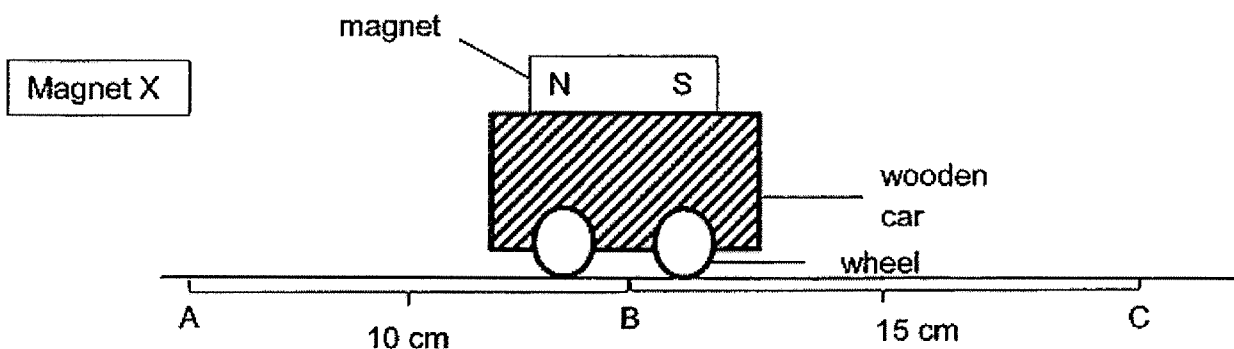

- (a) When magnet X is placed at position A, the wooden car moved from position A to B. Give a reason for his observation. [1]

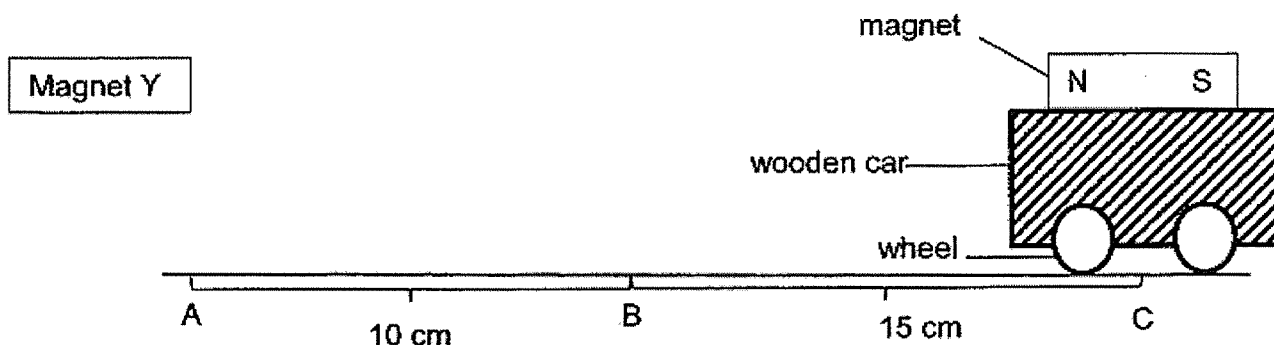

- (b) The wooden car was placed at position C. When magnet Y was placed at position A, the wooden car moved from position C to A. Based on his observations, which magnet, X or Y, is a stronger magnet. Explain your answer. [2]

Score	
	3

37 Ashlynn rubbed her eraser on a piece of paper. She saw some eraser shavings on the piece of paper.

(a) State another observation she would made of the eraser. [1]

The diagram below shows Ashlynn doing abseiling where she was going down a vertical wall using a rope.

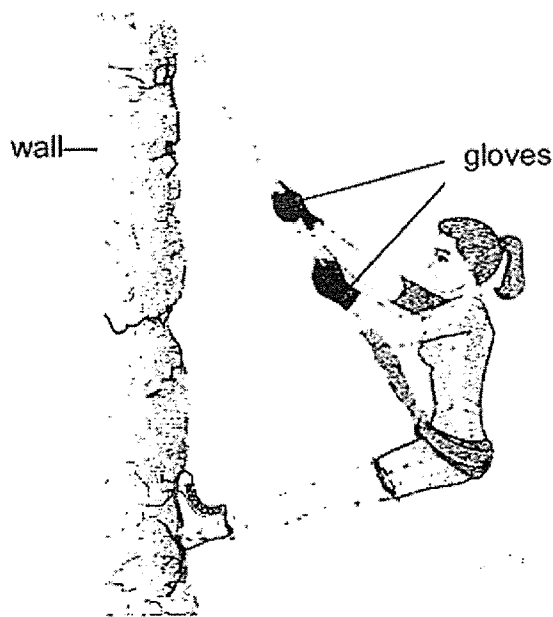

(b) Ashlynn said wearing gloves to pull on the rope while going down the wall would protect her hand. Explain why that was so. [1]

(c) Name another force that was acting on Ashlynn. [1]

Score	3
-------	---

38 Kelvin had three wooden frames, S, T and U.

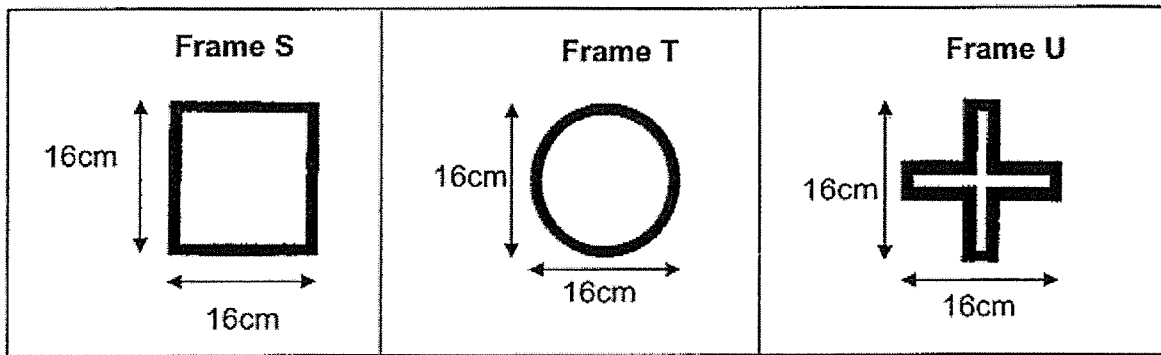

The set-up below shows light shining on the three wooden frames, S, T and U. They were placed at different positions from the torch.

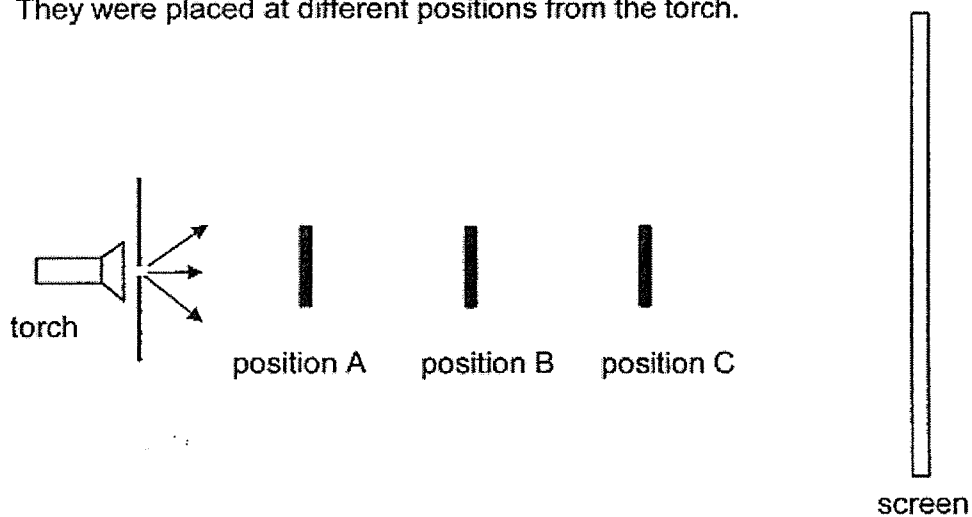

The diagram below shows the shadow of the objects on the screen.

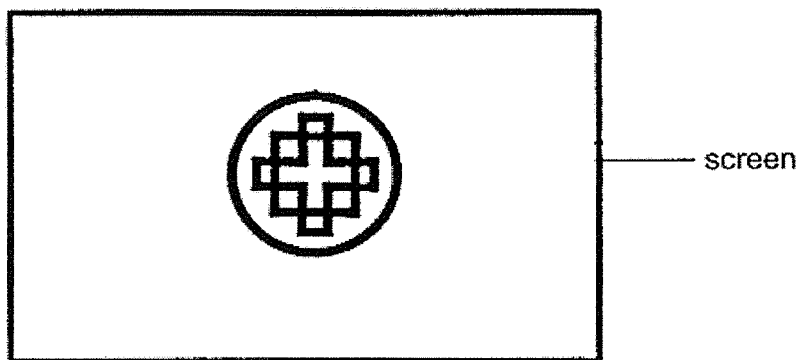

(a) Which wooden frame, S, T or U, was at position C? [1]

Continue on next page

Score	1
-------	---

Continued from previous page

Another piece of wood measuring 16 cm x 16 cm is placed at position M as shown below.

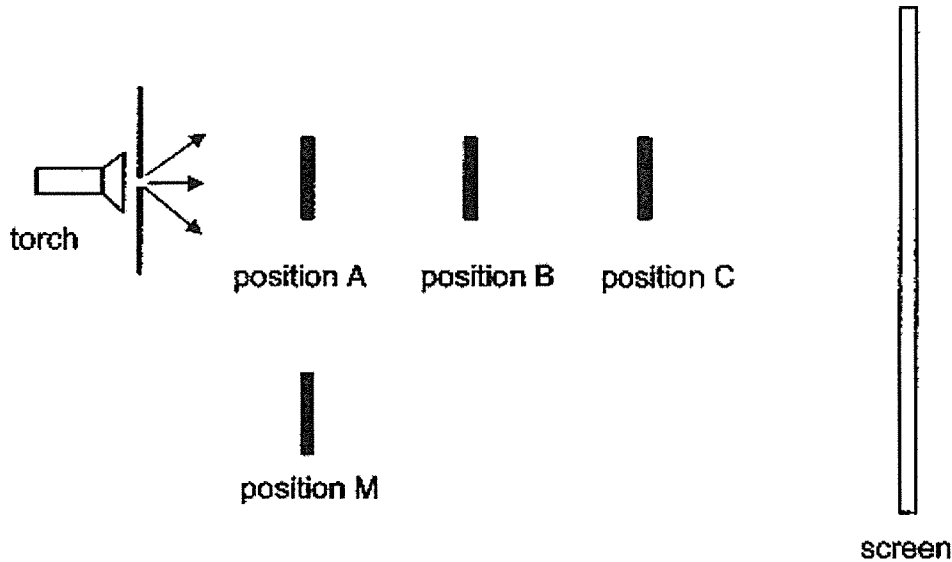

- (b) Will Kelvin still be able to observe the shadow that was cast on the screen earlier? Explain your answer. [1]

- (c) Which of the shadows will Kelvin observe if frames S, U and T are placed at positions A, B and C respectively?

Put a tick (✓) in the box provided that correctly represents the shadow observed. [1]

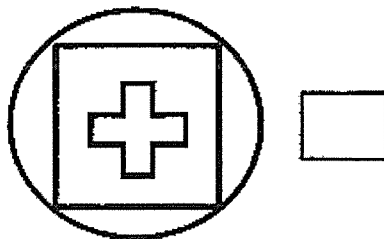
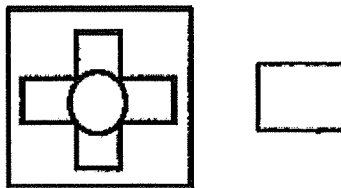

40

Score	/
	2

2020 P6 Science Prelim

- 39 Martha used the set-up below to find out the heat conductivity of materials P, Q and R. The materials were of the same length and thickness. They were placed below a beaker of water with the same amount of heat applied to the set-ups.

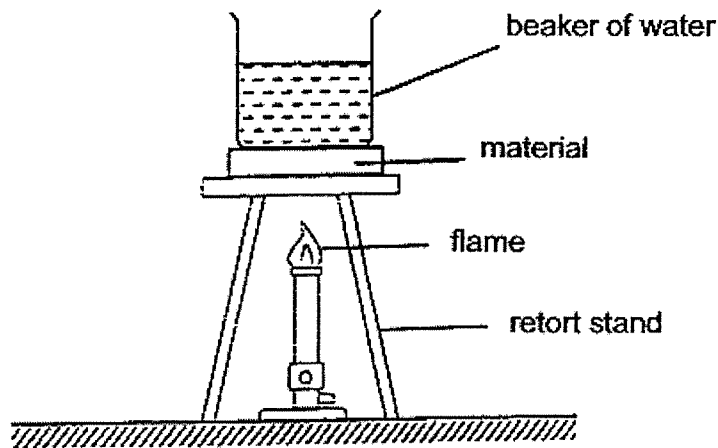

The heat conductivity of materials P, Q and R is as follows.

poorest heat conductor

best heat conductor

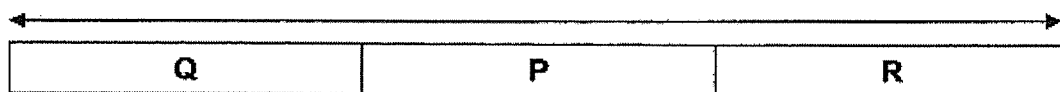

She recorded the time taken for the water in each set up to boil in the table below.

Materials	Time taken for water to start boiling (minutes)
P	10
Q	10
R	10

Martha's teacher told her that her experiment was not a fair test as the time taken for water to start boiling should not be 10 minutes for all the three containers as the heat conductivity of the materials are different.

- (a) Identify one of the constant variables which was not kept the same during the experiment and describe what she could have done to arrive at the result shown in the table above. [2]

Score	2
-------	---

Continued from previous page

- (b) What would be the temperature of water if Martha continued to heat the beakers of boiling water for another five minutes? [1]

Materials	Temperature of water (°C)
P	
Q	
R	

Score	1
-------	---

40. Two identical containers were each filled with three litres of water at 60°C. Each container was then placed in identical larger tanks filled with cotton wool. A tube and a pump were attached to each container to allow a continuous flow of water out of the container and then back again. Set-up A has a shorter tube than set-up B.

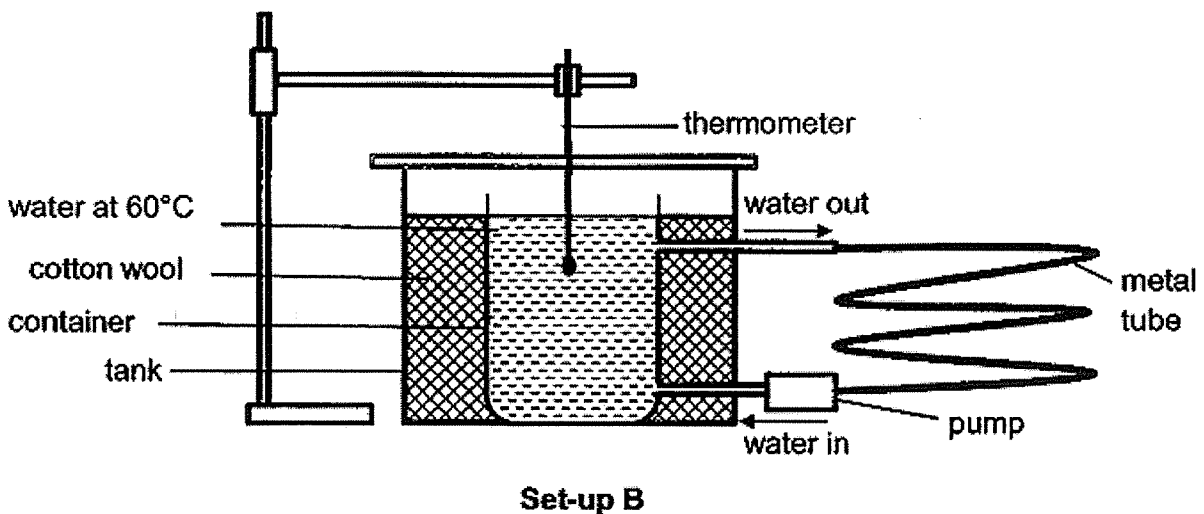
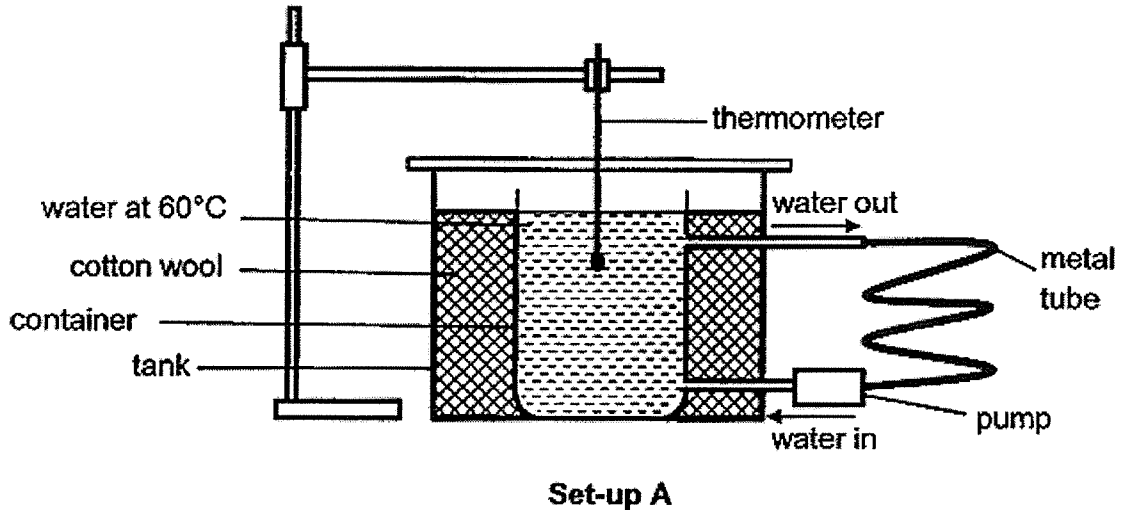

- (a) Given that the set-ups were placed together in the same room, in which set-up would the water reach room temperature first? Explain your answer clearly. [2]

Score	2
-------	---

Continued from previous page

It was found that the cotton wool is filled with air spaces, as shown in the diagram below.

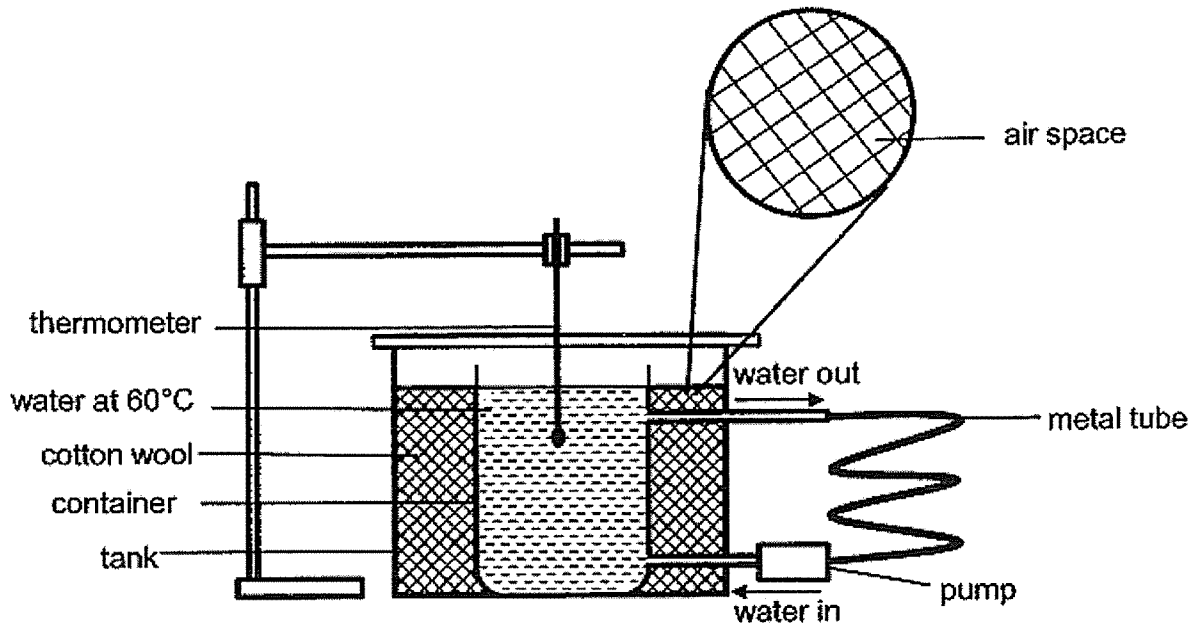

- (b) Explain the purpose of placing the containers into a larger tank filled with cotton wool. [2]

Score	2
-------	---

41 The roller coaster is brought to the highest point A.

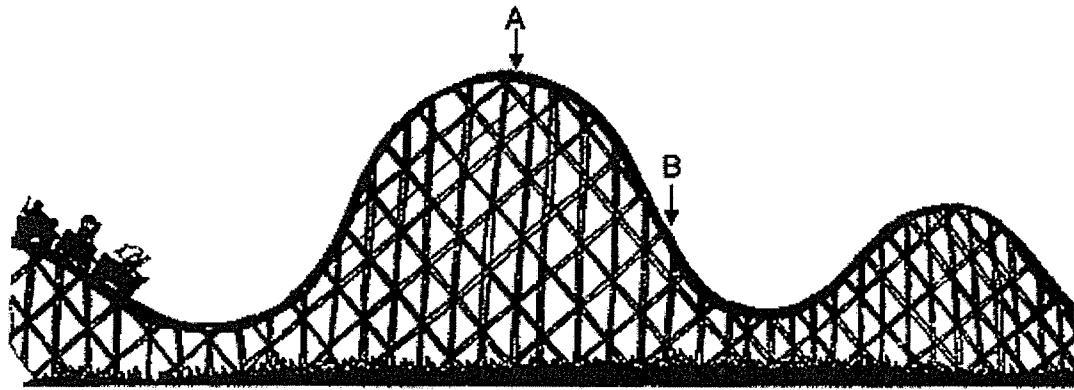

(a) Write down the energy conversion for the roller coaster as it moves from A to B. [1]

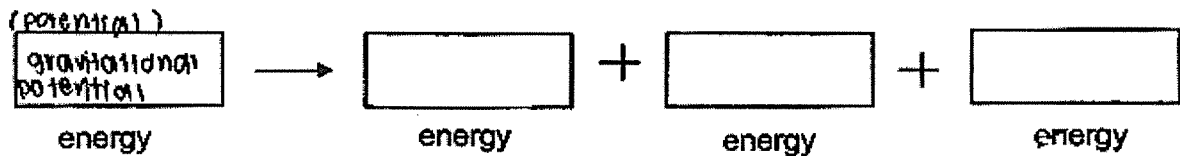

(b) Fill in the table with 'increase' or 'decrease' as the roller coaster moves down from point A to point B. [2]

Points	Potential Energy	Kinetic Energy	Speed
A to B			

END OF PAPER

Score	3
-------	---

SECTION A

Q 1	Q2	Q3	Q4	Q5	Q6	Q7	Q8	Q9	Q10
2	3	3	2	1	4	3	3	1	4
Q 11	Q12	Q13	Q14	Q15	Q16	Q17	Q18	Q19	Q20
3	3	1	3	1	3	4	4	2	2
Q 21	Q22	Q23	Q24	Q25	Q26	Q27	Q28		
2	3	1	4	2	2	3	3		

SECTION B

Q29)	a)X: can it make its own food Y: Bird nest fern b)spores
Q30)	a)Both of them reproduce from seeds. b)i)C ii)B iii)D c)Bar 2. The number of young plants of P are distance as the distance from the parent plant increases. The animals ate the thick juicy flesh of the fruit and passed but the indigestible seed in their droppings when animals moved away.
Q31)	a)It traps light energy from the sun to make food for the plant. b)ovary. c)leaves → stem ↓ fruits ↑ roots

Q32)	<p>a)As the distance between the lamp and the test tube increases the aquatic of light received by the plant decreased,Thus the rate of photosynthesis will decrease, producing bubbles.</p> <p>b)1)Intensity of light from the lamp. 2)Number of plants.</p> <p>c)Set-up B. The lamp was placed at a closer distance to the plant in B than in A. Thus, the light intensity in B would be higher than A and the plant in B can trap more light to make more food and photosynthesis faster allowing its mass to increase more and stored as starch in the plant.</p>
Q33)	<p>a)Tilt downwards to Y. Air around the candle will gain heat from the flame and rise up to go into X, pushing X up. Thus, the rod will tilt to Y.</p> <p>b)Cup X has a greater mass than M. At the start of the experiment. The rod would tilt downward to X. Thus, The rising hot air around the candle was able to push X.</p>
Q34)	<p>a)X: Melting Y: condensation</p> <p>b)i)Water vapour inside the sealed plastic bag gained heat from the hot bread and increased in temperature. The vapour then lost heat to the cooler inner surface of the sealed plastic bag and condensed to form tiny water droplets. Which slid down the plastic bag and dripped on the bread.</p> <p>ii)Open the sealed plastic bag.</p>
Q35)	<p>a)When the train moved completely in to the steel tunnel, the aluminium strips touched the steel tunnel and closed the gap in the circuit. Thus, the circuit was closed and electricity could flow through the circuit, enabling the bulb to light up.</p> <p>b)The bulb will flash, and the light bulb will light up and then not light up then light up again and soon.</p>

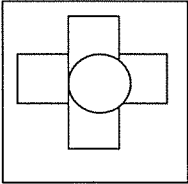
Q36)	<p>a) X's north pole and the magnet on the car's north pole was facing each other and repelled, pushing the car to B.</p> <p>b) Thus, Y exerted a greater magnetic force of attraction than the force of repulsion exerted by X on the magnet on the car.</p>
Q37)	<p>a) The eraser will decrease in size.</p> <p>b) The gloves prevent her palms from getting cut due to friction between her palms and the rope.</p> <p>c) Gravitation Force.</p>
Q38)	<p>a) S.</p> <p>b) Yes as light travels in a straight line, the other piece of wood at M did not block light to form a shadow.</p> <p>c) </p>
Q39)	<p>a) She could put the greatest amount of water in the beaker when R was used and the amount of water in the beaker was the least when Q was used.</p> <p>c) P --- 100°C Q --- 100°C R --- 100°C</p>
Q40)	<p>40) a) B. The metal tubes are longer thus is a larger surface area exposed to the surrounding air. Thus, it conducts more than heat from the water to the surrounding air.</p> <p>b) Air in the cotton wool is a poor conductor of heat. This slows down reduced heat loss from the water in the container to the surrounding air. This allows a more accurate measurement of rate of heat loss of the water through the metal tube to the surrounding air most of the heat loss takes place at the metal tube.</p>
Q41)	<p>a) gravitational potential → kinetic + heat + sound</p> <p>b) Decrease / Increase / Increase</p>